

## Safety Instructions



0,1,2,4,5b,7,8,9,11,  
12,15,16,17,19,20,21,  
22,23,29



Info Hotline 

**+49 (0) 5041 998 389**

Mon. - Do. 7<sup>00</sup> - 20<sup>00</sup>

Fr. 7<sup>00</sup> - 17<sup>00</sup>

Paulmann Licht GmbH  
31832 Springe / Germany  
www.paulmann.com

Art.-Nr.:  
507000319

(+MA 173)

PBO 08 / 09

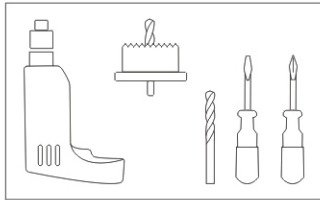

**B**



**C**

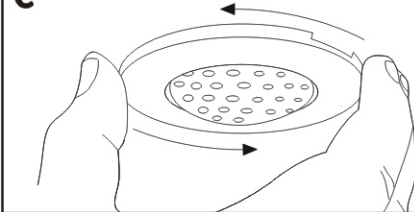

**1**

**3**

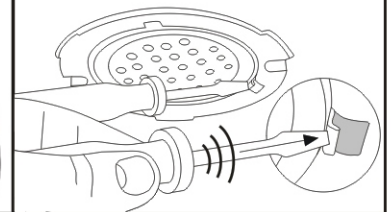

**2**

**4**

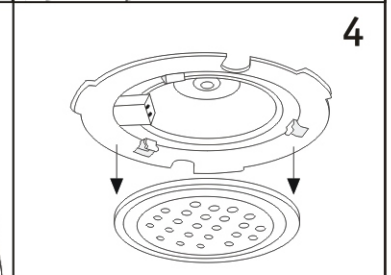
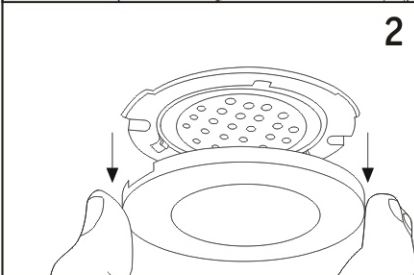

**A**

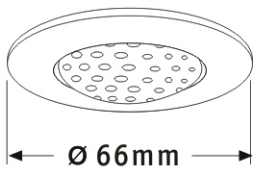

**D**

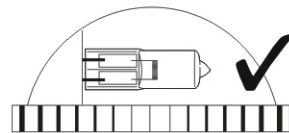
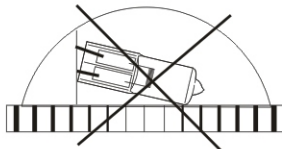
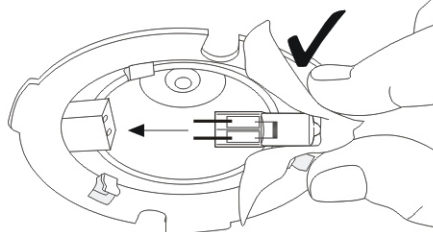
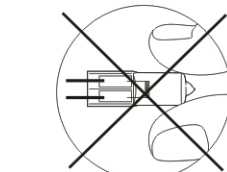

**E**

„CLICK“

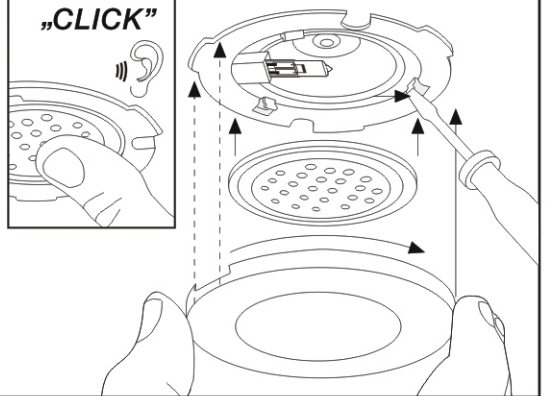

10W G4 831.109  
20W G4 831.209

**F**

12V

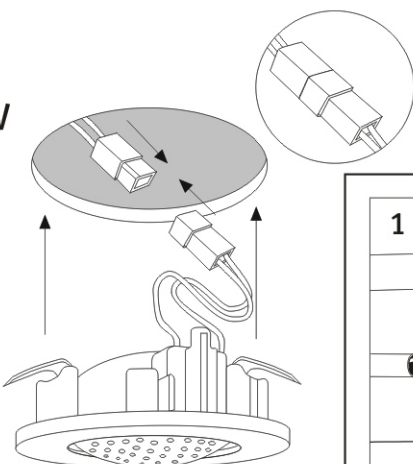

**1**

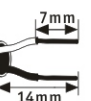

**2**

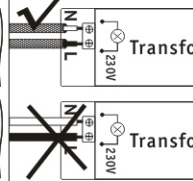
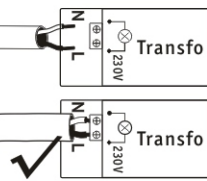
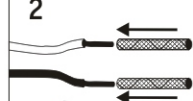

**G**

