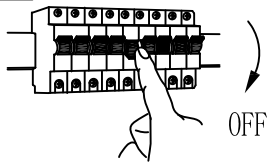
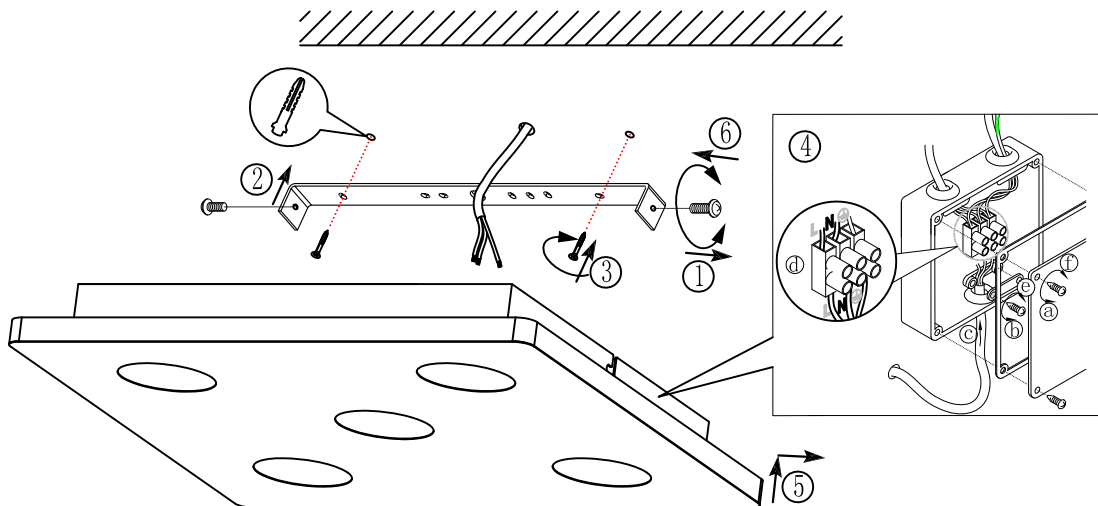
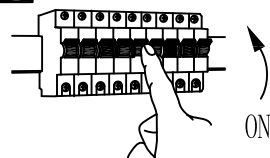

**A****B****C**

BLA96939

www.eglo.com