

# INSTRUCTION SHEET

A

B

39104

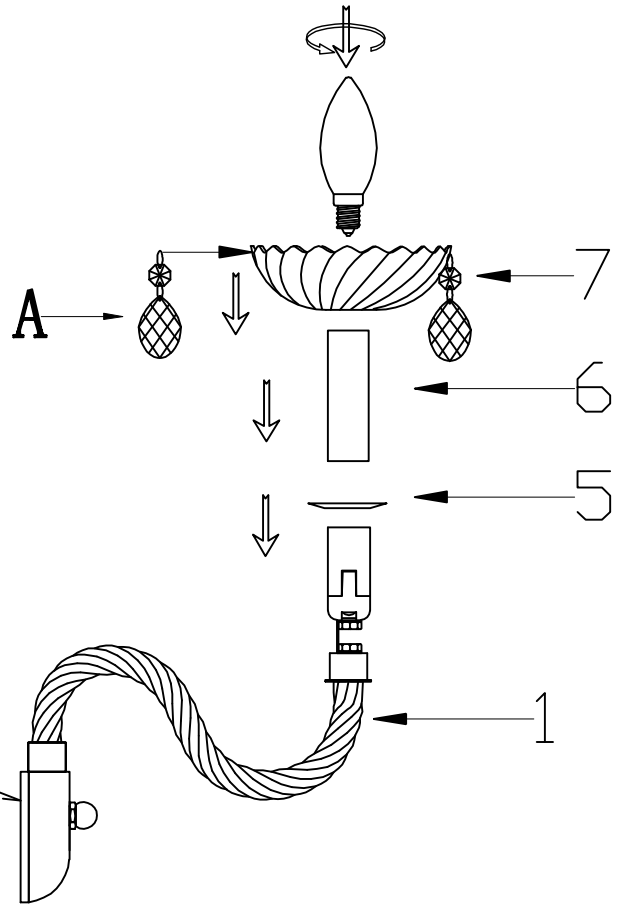
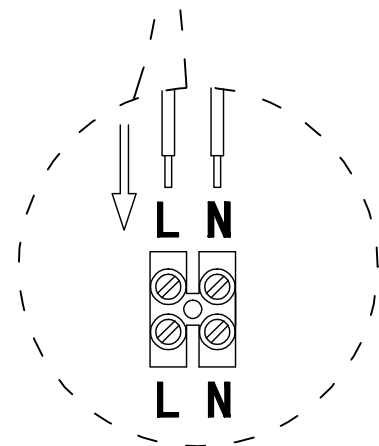
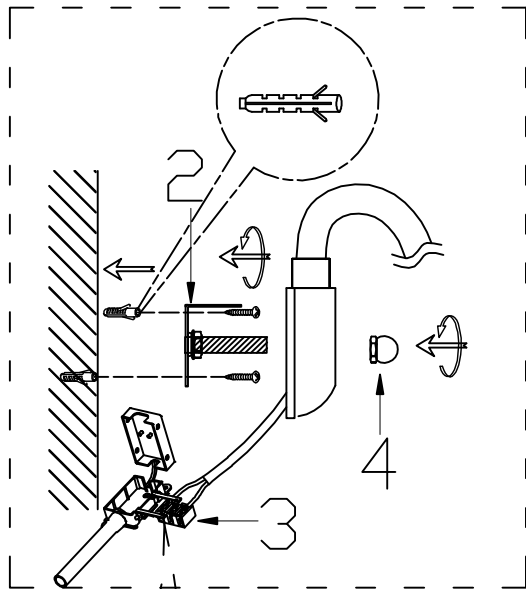
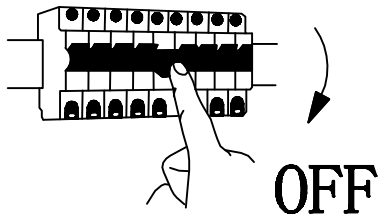

C

